

IM-000640B

pipa™ aire rx



nuna®

Thank you!

You've just purchased a Nuna product, and you can be sure that your child is getting the best there is. Our products are expertly engineered for safety, with luxury fabrics and sophisticated style.

Whatever made you fall in love with Nuna, rest assured your adventures with your little one will be easier from now on, freeing you to enjoy more happy family moments together.

Easy Installation

Our products are designed to make your life easier, so installing this child restraint doesn't require outside assistance. While we encourage the use of Certified Child Passenger Safety Technicians to ensure you have installed the seat correctly, you can install the child restraint in your vehicle without these professionals by carefully reading and following these instructions.



**IMPORTANT!
KEEP THESE
INSTRUCTIONS
FOR FUTURE
REFERENCE:
*READ CAREFULLY***

Contents

About PIPA aire rx	
Product Information	4
Product Registration	4
Recall Information	4
Limited Warranty	5
Contact	5
Child Usage Requirements	6
Warnings	6
Car Seat Use after a Crash	11
Vehicle Compatibility	12
PIPA aire rx Parts List	16
PIPA RELX™ Base Parts List	18
Using PIPA aire rx	
Product Overview	20
Product Use	32
Installation	42
With PIPA RELX base	42
Child Restraint Only Install	56
In an Aircraft	60
On a Stroller	60
Accessories	62
Cleaning and Maintenance	64

Product Information

Model Number: _____

Manufactured in (date): _____

Product Registration

Please fill in the above information. The model number and the manufactured in date are located on a label on the bottom of your child restraint. Fill out the prepaid registration postcard attached to the seat pad and mail it today.

Child restraints could be recalled for safety reasons. You must register this restraint to be reached in a recall. Send your name, address, e-mail address if available and the restraint's model number and manufacturing date to:

Nuna Baby Essentials Inc.
70 Thousand Oaks Blvd.
Morgantown, PA 19543

or call 1.855.NUNA.USA

Recall Information

For recall information, call the U.S. Government's Vehicle Safety Hotline at: 1.888.327.4236 (TTY: 1.800.424.9153) or go to <http://www.NHTSA.gov>

Limited Warranty

We have purposely designed our high-quality products so that they can grow with both your child and your family. Because we stand by our product, our gear is covered by a custom limited warranty per product, starting from the day it was purchased. Please have the proof of purchase, model number and manufactured in date available when you contact us.

For warranty information, please visit:
www.nunababy.com/warranty

Contact

For replacement parts, service, or additional warranty questions, please contact our customer service department.

In the USA:
infousa@nunababy.com
www.nunababy.com
1.855.NUNA.USA

Child Usage Requirements

This child restraint is suitable for use with children who meet the following requirements:

Weight: 4 to 30 lb (2 to 13.6 kg)

Height: less than 30 inches (76 cm)

It is recommended to keep your child rear facing as long as possible, until at least 2 years old.

WARNING

DEATH OR SERIOUS INJURY can occur if you fail to follow the warnings, instructions and labels on the child restraint.

A child's safety is your responsibility. **NEVER** leave your child unattended.

Read all instructions before use of this child restraint or installation in a vehicle. In addition, read the vehicle owner's manual for information on child restraint installation.

Store the instruction manual in the pocket located within the seat pad.

Register your child restraint with the manufacturer.

Secure this child restraint with the vehicle's child restraint anchorage system if available, or with a vehicle belt.

This child restraint can **ONLY** be used in a rear facing position when using in a vehicle. The child restraint cannot be properly secured in a forward facing position, and will be unsafe. Use only with children who weigh between 4 and 30 pounds (2 and 13.6 kg) and whose height is 30 inches (76 cm) or less. Exceeding these height and weight limits is unsafe.

Cover the child restraint when your vehicle is parked in sunlight. Parts of a child restraint can become very hot if left in the sun, and can burn a child's skin. Check for hot parts before putting your child in the child restraint.

NEVER use a car seat that has been involved in a moderate to severe crash. **See page 11** to learn what is classified as a moderate to severe crash.

Snugly adjust the belts provided with this child restraint around your child.

If straps are not snugly adjusted, child may be ejected from seat in the event of an accident.

A snug strap should not allow any slack. It lies in a relatively straight line without sagging. It does not press on the child's flesh or push the child's body into an unnatural position.

EXPIRATION DATE Check the label on the underside of the base or child restraint for expiration date information.

FALL HAZARD Child's activity can move carrier. **NEVER** place carrier on counter tops, tables, or any other elevated surface. Always stay within arm's reach whenever carrier is not on floor/ground. Be sure handle locks into position before lifting carrier.

The carrier can fall from a shopping cart. **DO NOT** use on a shopping cart.



STRANGULATION HAZARD Children have **STRANGLED** in loose or partially buckled harness straps. Fully restrain the child even when carrier is used outside the vehicle.

SUFFOCATION HAZARD Infant carrier can roll over on soft surfaces and suffocate child. **NEVER** place carrier on beds, sofas, or other soft surfaces.

ALWAYS check child restraint to base connection.

DO NOT allow anyone who has not read the instruction manual to install or use this child restraint.

DO NOT allow child restraint or handle to contact the vehicle interior (side of car door or seat in front) when installed on base.

DO NOT use child restraint if it has frayed or cut harness straps, or is damaged in any way. To find out if damaged parts are replaceable, call 1-855-NUNA-USA.

NEVER modify any part of the child restraint.

DO NOT use any products or accessories with this child restraint unless they are approved by Nuna for use with this child restraint. Doing so may be unsafe and may void the warranty.

DO NOT leave child restraint and base in vehicle when uninstalled, even when unoccupied. In a crash, it could become a projectile and injure other vehicle occupants.

NEVER use clothing or blankets that interfere with providing a properly tightened harness. An unsecured or improperly harnessed child can come out of the restraint during a crash. Place blankets over child **AFTER** harness has been properly tightened.

Only use with Nuna strollers or appropriate Nuna adapters designed for use with other strollers.

Car Seat Use after a Crash

The National Highway Traffic Safety Administration (NHTSA) recommends that car seats be replaced following a moderate or severe crash. Car seats do not automatically need to be replaced following a minor crash.

What defines a minor crash?

A minor crash is one in which **ALL** of the following apply:

- The vehicle was able to be driven away from the crash site.
- The vehicle door nearest the car seat was not damaged.
- None of the passengers in the vehicle sustained any injuries in the crash.
- If the vehicle has air bags, none of the air bags deployed during the crash; and
- There is no visible damage to the car seat.

NEVER use a car seat that has been involved in a moderate to severe crash. Contact Nuna with questions or concerns about your seat.

Information from nhtsa.gov

Vehicle Compatibility

You **MUST** read and understand **ALL** child restraint related instructions and warnings in your vehicle owner's manual to correctly and safely use this child restraint in your vehicle.

This child restraint can **ONLY** be installed on vehicle seats that face forward. **DO NOT** install in seats that face to the sides or rear of the vehicle.

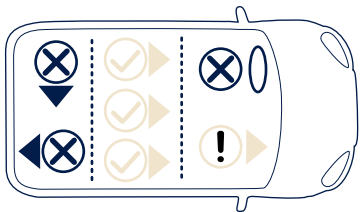

According to accident statistics, children are safer when properly restrained in the rear seating positions than in the front seating positions.

Vehicle Belt Use

Refer to your vehicle owner's manual to determine if the belts in your vehicle lock by switching the seat belt's retractor **OR** if they have a locking latch plate that locks the vehicle's seat belt so they will hold the child restraint tightly without loosening.

(Vehicle Belt Use continued on the next page)



NEVER install this child restraint rear facing in a vehicle seating position with a frontal air bag unless it is turned off. Airbags inflate with great force and can cause severe injury to a

child's neck and spine. If your vehicle is equipped with passenger side air bags, check your vehicle owner's manual for child restraint installation instructions.

These vehicle belts **CANNOT BE USED** with your child restraint. Install with lower anchors instead.

1 - Motorized Belts (Automatic)

These should not be used unless the shoulder belt can be removed, the lap belt is locked and use is allowed by the vehicle manufacturer.

2 - Dual Retractor Belts

If allowed by the manufacturer, the lap belt only may be used to secure the child restraint in accordance with this manual and the vehicle owner's manual.

3 - Non-Locking (ELR) Lap Belts

This belt locks in a crash or sudden stop and should only be used with a belt shortening clip. Contact your vehicle manufacturer if needed.

4 - Airbag/Inflatable Belts

This belt cannot be used to install this child restraint.

5 - Door Mounted Belts

This belt cannot be used to install this child restraint.

6 - Lap Belts forward of Seat Bight

This belt (where the seat bottom and seat back meet) should not be used to install this child restraint.

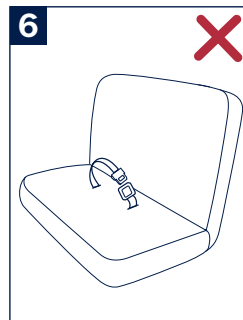
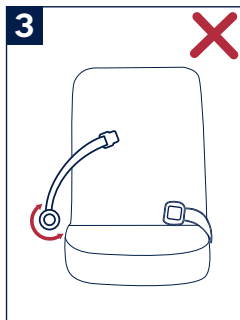
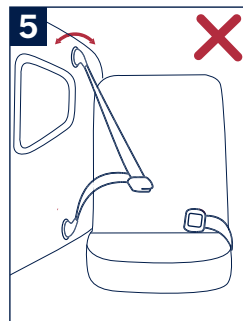
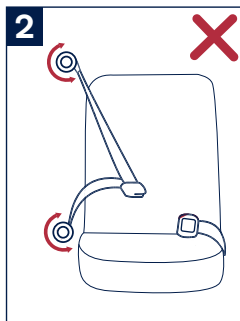
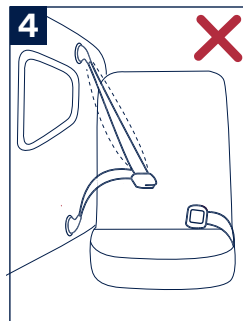
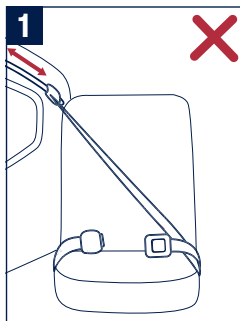

PIPA™ aire rx Parts List

Make sure all parts are available before assembly. The infant carrier module and base can be sold separately. If any part is missing, please contact Nuna (see page 5 for information). No tools are required for assembly.

- | | | | |
|----|---|----|--------------------------------|
| 1 | Head Support x2* | 14 | Handle Adjustment Button |
| 2 | Seat Pad | 15 | Stroller Release Button (Side) |
| 3 | Shoulder Pads x2 set | 16 | Handle |
| 4 | Chest Clip | 17 | Sky Drape™ Zipper |
| 5 | Body Support x2 | 18 | Canopy Window |
| 6 | Low Birth Weight Pillow (inside back of Body Support) | 19 | Canopy |
| 7 | Buckle | 20 | Stroller Release Button (Rear) |
| 8 | Harness Adjustment Button | 21 | Belt Guide (Shoulder Belt) |
| 9 | Harness Adjustment Strap | 22 | Canopy Mount |
| 10 | Crotch Pad x2 | 23 | Harness Slots |
| 11 | Instruction Manual Pocket | 24 | Base Attachment Bars |
| 12 | Belt Guide (Lap Belt) | 25 | Shoulder Harness Straps |
| 13 | Magnetic Buckle Holder | 26 | Shoulder Harness Loop |
| | | 27 | Harness Splitter Plate |

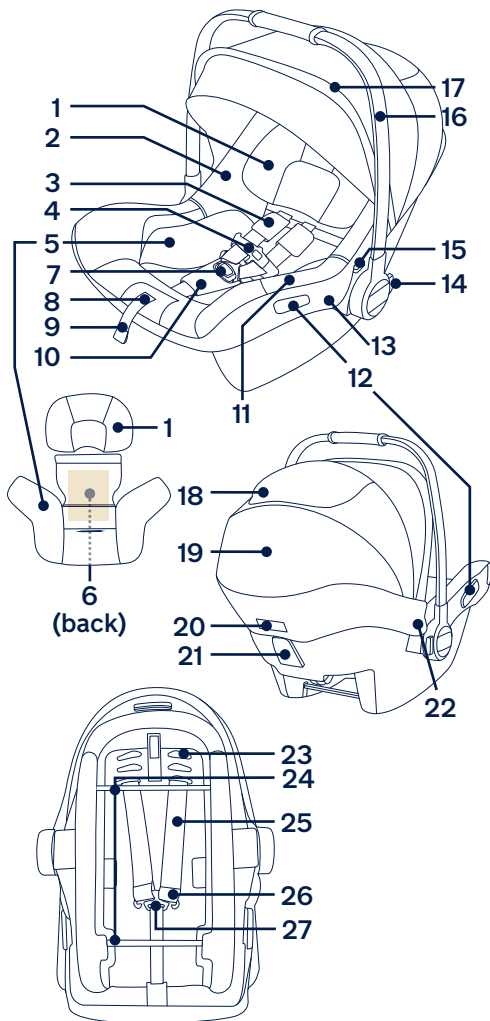

*Certain models only

PIPA RELX™ Base Parts List

Make sure all parts are available before assembly. If any part is missing, please contact Nuna (see page 5 for information). No tools are required for assembly.

- 1 Latch Guides
- 2 Vehicle Belt Lock Off
- 3 Lock Off Release Button
- 4 Belt Positioner
- 5 Rigid Latch (Lower Anchors)
- 6 Rigid Latch Release Button
- 7 Recline Indicator Window
- 8 Recline Adjustment Button
- 9 Child Restraint Release Button
- 10 Stability Leg
- 11 Stability Leg Adjustment Button
- 12 Stability Leg Indicator
- 13 Stability Leg Storage Release Button
- 14 Stability Leg Storage

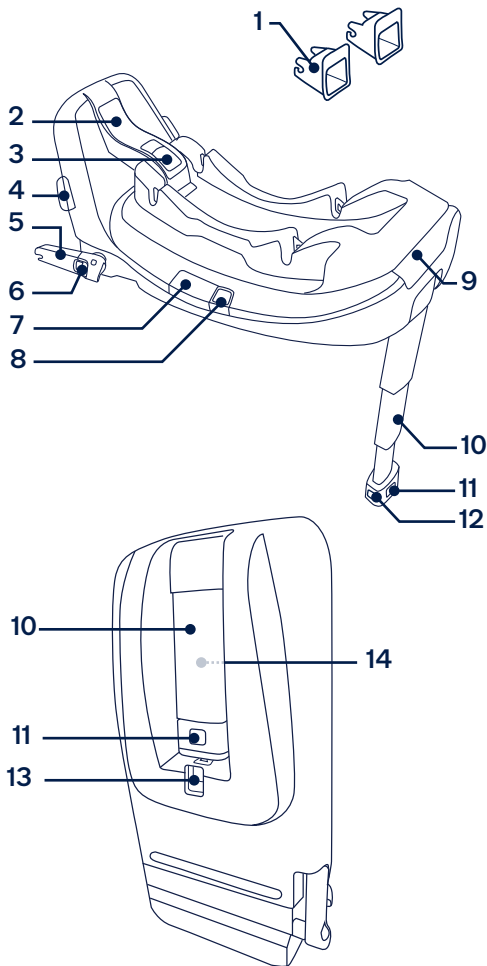

Product Overview

Sky Drape

- 1 - Unzip the zipper behind the front canopy bow.
- 2 - Pull the Sky drape out of the compartment and attach it to the magnets on each corner of the front of the carrier.

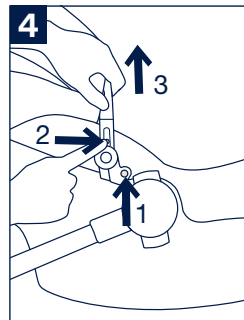
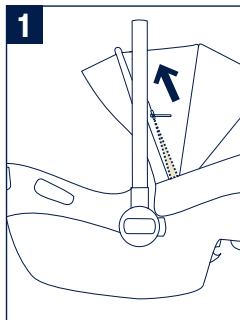

Canopy

- 3 - The canopy window can be opened for ventilation.
- 4 - To remove the canopy, undo the snap on the canopy mount (1). Press the button in the canopy mount (2). Pull the canopy bow out (3).

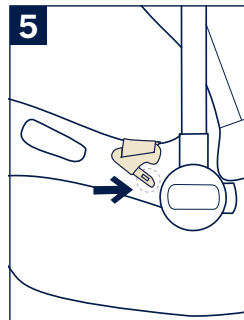
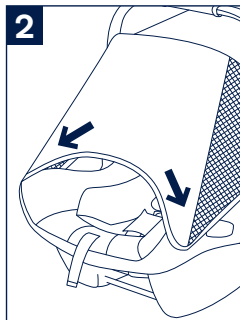

Magnetic Buckle Holders

- 5 - Loosen and unbuckle harness. Place the buckle tongues against the magnetic area on the side of the child restraint so that the tongues are held in place.

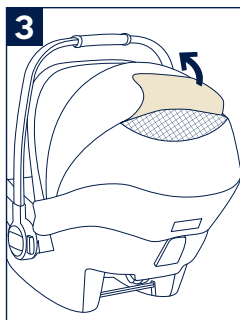

Shoulder Pads

1 - Shoulder pads are removable.

Unbutton the two snaps to remove.

Crotch Pad

2 - Crotch pad is removable.

To remove, slide the plastic tab out from behind the buckle.

3 - Pull the crotch pad off of the buckle.

⚠ Shoulder and crotch pads **MUST** be removed once the child reaches 22 lb.

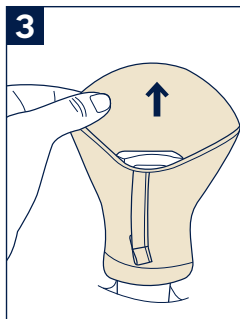
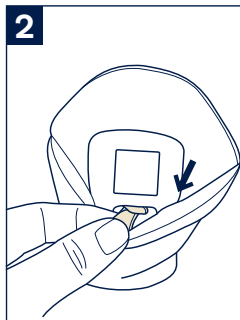
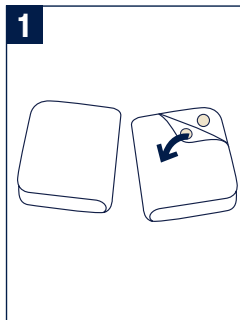

Head and Body Support

The head and body supports can be used as necessary, to provide a snug fit for small babies.

⚠ The head support straps cannot go through the same slots as the harness and should only be used in the top two harness slot positions.

- 1** - To remove the head support, unfasten the hook and loop ends behind the seat fabric.
- 2** - Then, pull the head support straps through the harness slots.
- 3** - To remove the body support, unbuckle the harness and route the buckle and crotch belt through the bottom slot of the body support.
- 4** - The low birth weight pillow (located on the back of the body support) can be used in the body support for even smaller babies, but **MUST** be removed once a snug fit can be achieved without it, at approximately 11 lb.

To remove the low birth weight pillow, unfasten the hook and loop on the back of the body support and pull out the pillow.

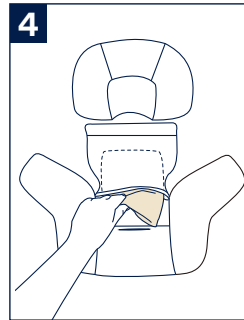
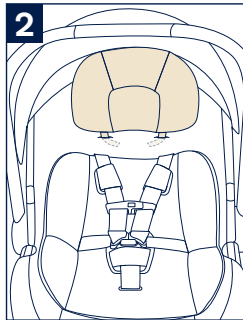
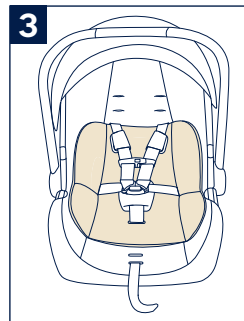
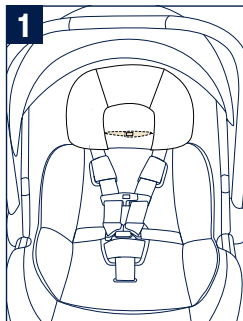

Shoulder Belts

- 1 - Tighten harness to fit snugly on child's shoulders. It is snug if you cannot pinch a fold horizontally in the strap.
- 2 - Harness straps must be at or just below shoulders.
- 3 - To adjust shoulder harness height, remove child and loosen harness by pressing the harness adjustment button (1) while pulling on the harness strap (2). The harness adjustment button is located inside the slot on the seat pad.
- 4 - Turn child restraint over and remove one harness loop from metal splitter plate.
- 5 - Turn child restraint back to the front. Pull loose end of harness loop out through slot and place in correct slot.
- 6 - Repeat process for second shoulder harness strap and then re-attach harness to splitter plate.

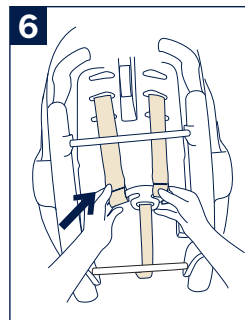
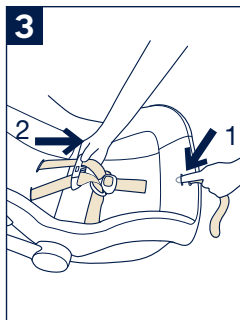
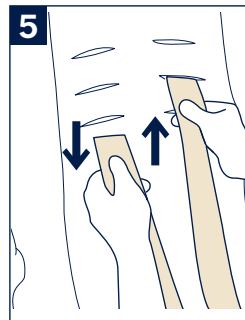
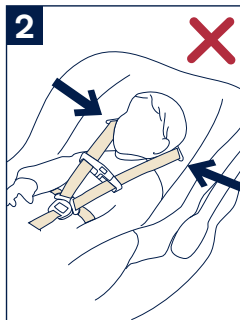
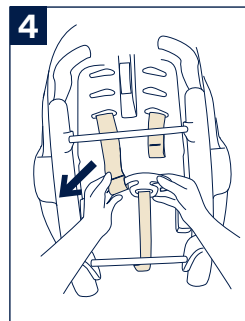
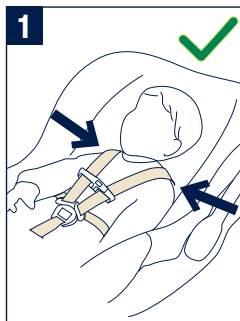

Shoulder Belts *(continued)*

- 1 - **⚠ DO NOT** allow harness to pass over base attachment bars.
- 2 - Top of child's head should be at least 1 inch below top of child restraint.

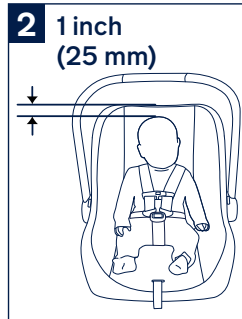
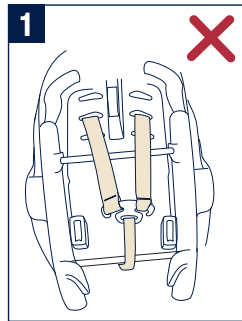

Handle Adjustment

- 1 - To adjust the handle position, squeeze handle buttons on both sides. **(1)**

Rotate handle until it clicks into a locked position. **(2)**

- 2 - The handle has 3 locked positions (including carry position).

- ⚠** Be sure handle is **locked in the carry position** before lifting child restraint by handle. An unlocked handle could move unexpectedly, causing injury to child.

Nuna recommends to have the handle in the carry position when in the vehicle. This allows space between front/rear seats and easier install/removal of the carrier.

- ⚠** Handle **MUST NOT** contact the vehicle interior (side of car or seat in front) when installed.

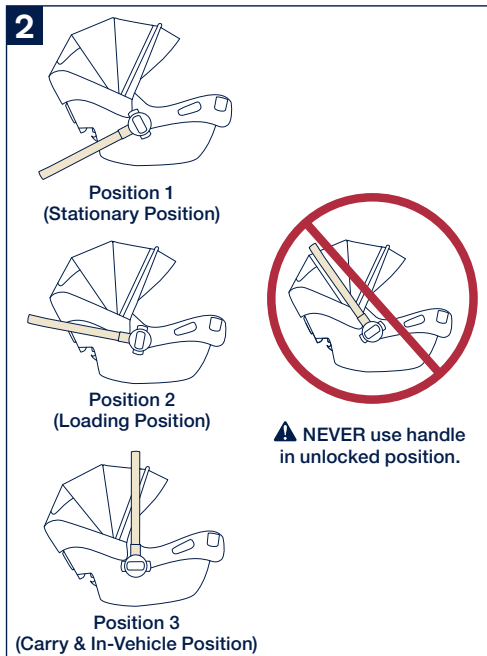
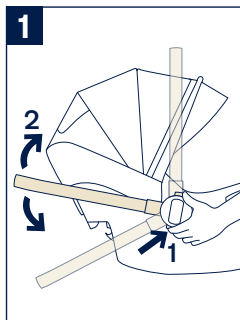

Product Use

- 1 - Top of child's head should be at least 1 inch below top of child restraint.

Securing Child in Child Restraint

- 2 - Loosen harness by pressing on adjustment button (1) while pulling on the harness straps. (2)
- 3 - Press button to release the halves of the chest clip. (1) Separate chest clip and spread harness straps apart. (2) Press buckle button and remove buckle tongues. (3)
- 4 - Place child in child restraint in seated position. The child should be seated against both the back and bottom of the seat with no gap behind the child. Do not allow child to slouch.
- 5 - **⚠** Harness straps must be positioned at or just below child's shoulders to avoid injury.

Gently guide child's arms through harness straps. If more harness length is needed, see page 26 for instructions.

(continued on the next page)

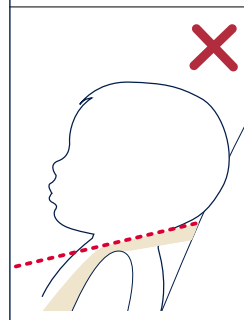
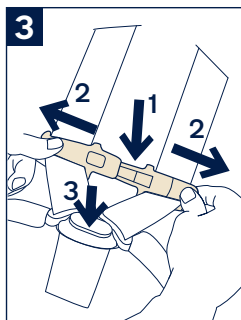
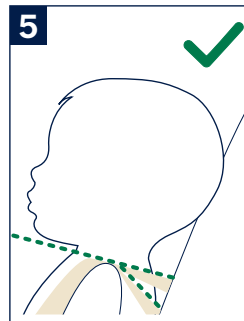
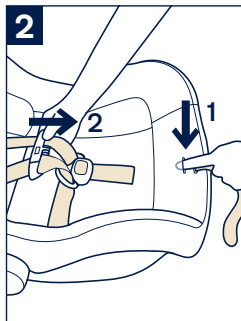
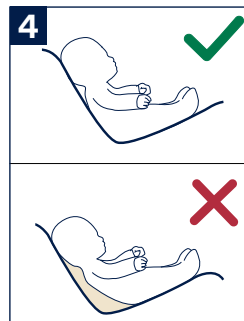
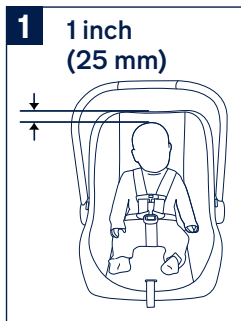

Securing Child in Child Restraint

(continued)

- 1 - Insert buckle tongues into buckle.
- 2 - Listen for clicks. Pull on buckle to verify it is latched.
- 3 - Snap the chest clip together and temporarily slide towards buckle for tightening of harness.
- 4 - Tighten harness by pulling on the adjustment strap (1). Pull any excess harness webbing through the buckle towards the child's shoulders (2) and pull again on the adjustment strap. This may need to be repeated several times for proper fit.

Verify that the harness is snug around the child's waist and shoulders.

- 5 - Position the chest clip at child's armpit level.

(continued on the next page)

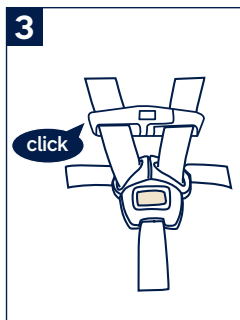
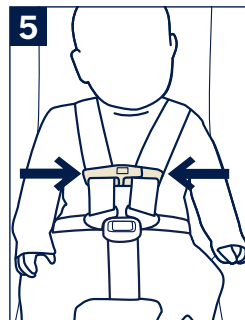
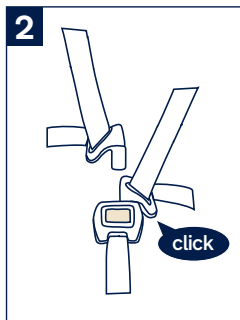
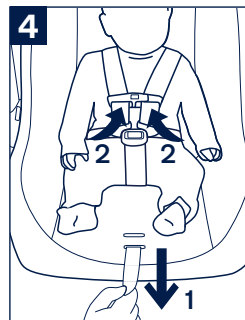
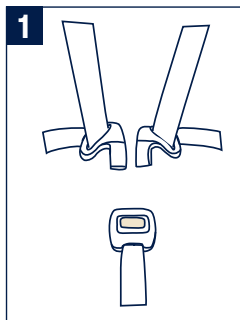

Securing Child in Child Restraint

(continued)

Make sure that nothing interferes with the harness. Make sure harness is snug around child and lays flat. Serious injury or death could occur to a child that is not secured properly.

If child is not secured properly, child could be ejected in a sudden stop or crash, resulting in serious injury or death.

Check that Child is Secure

- Buckle is fastened.
- Harness straps are not twisted.
- Harness is snug – A snug harness cannot be pinched horizontally, and should not allow any slack.
- Chest clip is level with armpits.
- Harness straps are positioned at or below child's shoulders.
- If the child weighs 22 lb or more, shoulder and crotch pads have been removed.

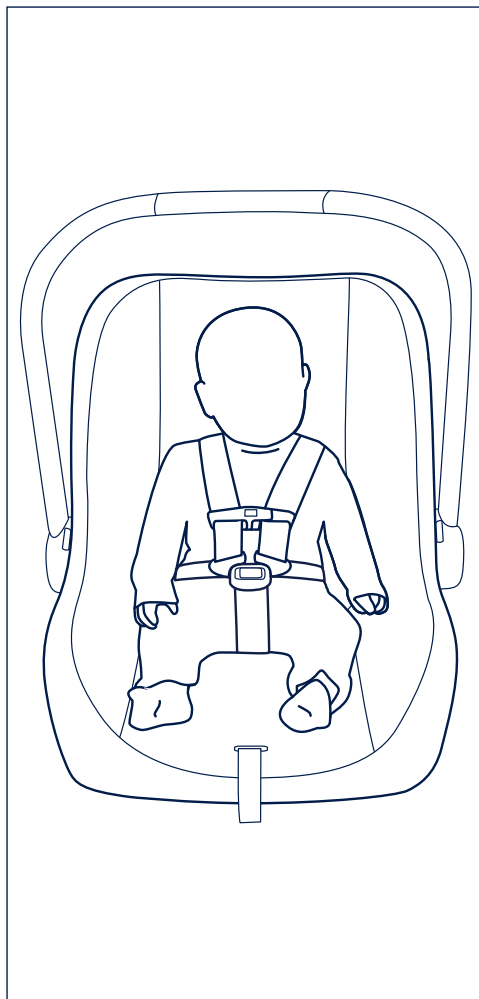

PIPA RELX™ Base Stability Leg

Refer to vehicle owner's manual to determine if stability leg can be used. See page 42 for base installation instructions.

- 1 - Press release button on bottom of base to release the stability leg from storage.
- 2 - Let the stability leg hang over the edge of the vehicle seat. After correctly installing the base on the vehicle seat, press the stability leg adjustment button and extend the stability leg perpendicular to the floor.
- 3 - Extend stability leg far enough that it contacts the floor, the stability leg indicator turns green, and the leg locks into position. Make sure the stability leg is firmly planted on the floor of the vehicle and does not easily slide around.
- 4 - Indicators should show green, meaning the stability leg is properly contacting the floor.

 If the stability leg indicator shows red, the stability leg is not making firm contact with the vehicle floor. Adjust as needed. **Stability leg should be perpendicular to the floor.**

(continued on the next page)

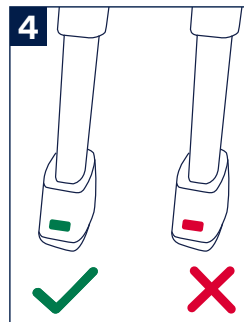
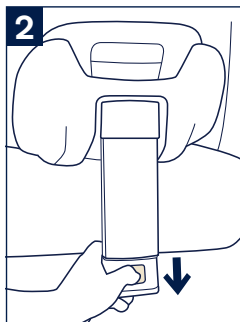
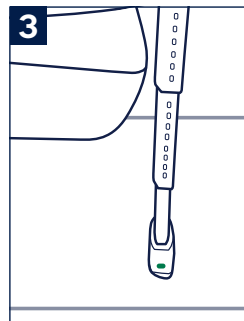
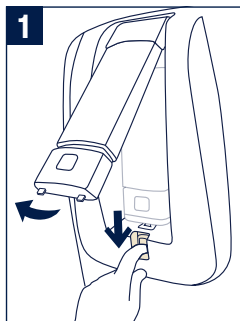

PIPA RELX™ Base Stability Leg

(continued)

1 - If stability leg lifts base more than 1 inch off the seat, adjust as needed to close the gap.

⚠ **DO NOT** use stability leg to recline the base. The recline adjustment feature is meant to recline the base.

2 - Always store stability leg when not in use. Press adjustment button to shorten stability leg, then push leg into storage area. Push until the release button clicks into place.

The stability leg can be used or stored for both rigid latch and vehicle belt installation.

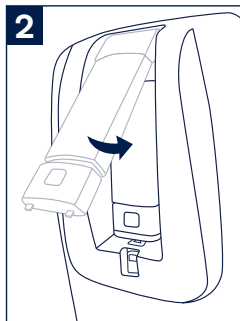
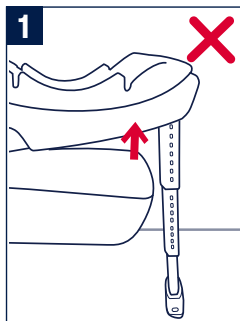

Installation

! If child is not secured properly, child could be ejected in a sudden stop or crash, resulting in serious injury or death.

PIPA RELX™ Base Installation Using Rigid Latch (Lower Anchors)

- 1 - Rotate rigid latch (lower anchors) down and point them away from base.
- 2 - Position base in a forward facing vehicle seat with the stability leg deployed (if using) (p.38).

It is recommended that you use the stability leg, which reduces crash forces in the event of an accident.

- 3 - If preferred, install latch guides on vehicle  lower anchor bars.
- 4 - Grasp rigid latch anchors and push down and forward to connect to vehicle lower anchor bars.

Be sure that the base bottom is firmly seated on vehicle seating surface and there is no gap between the base bottom and vehicle seat.

(continued on the next page)

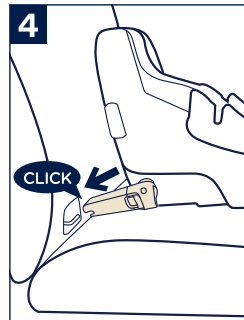
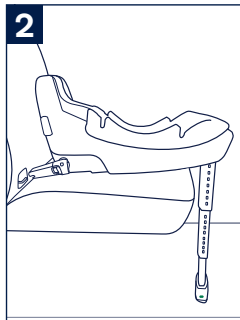
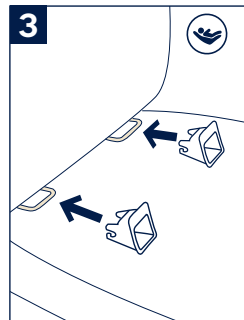

PIPA RELX™ Base Installation Using Rigid Latch (Lower Anchors)

(continued)

- 1 - Check installation by pulling on the base **AND** seeing that green is indicated on the connectors.
- 2 -  The rigid latch must be attached and locked onto the vehicle anchor bars with the indicator showing green. If used, the stability leg indicator must show green.

Retracted Positions

- 3 - There are three positions to which the bottom of the base retracts. In some vehicles, this is necessary to allow the base to sit against the vehicle seat back.
- 4 - If there is a gap between the back of the base and the vehicle seat **after** the rigid latch lower anchors have been attached, push on the top and/or back of the base until it touches the vehicle seat and a “click” indicates it’s locked into a retracted position.

A gap is acceptable if the base clicks through **all** retracted positions but is still not fully against the vehicle seat.

(continued on the next page)

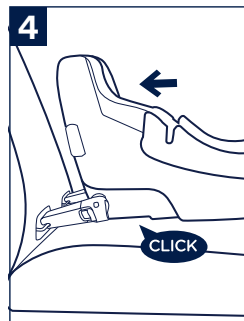
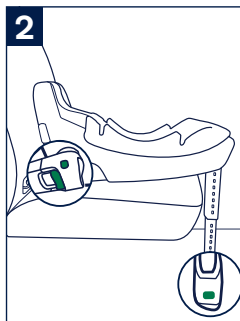
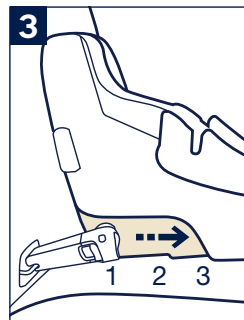
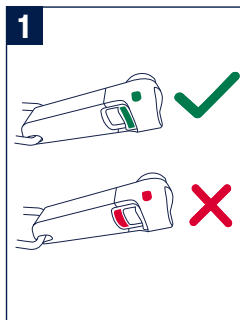

PIPA RELX™ Base Installation Using Rigid Latch (Lower Anchors) *(continued)*

- 1 - You can reset the retracted base back to its original position by unhooking the rigid latch from the vehicle lower anchor bars (p.54) and rotating the rigid latch up into the storage position.



Check the Installation

- 2 - Test the security of the installation **near the rigid latch (a)**, not at **the end of the base (or seat) (b)**.

- Some side-to-side movement on the lower anchor bars could occur. This does not create an unsafe condition if the rigid latch (lower anchors) are attached to these bars on both sides of the base.
- The rigid latch indicators must show green.
- The stability leg indicator (if using) must show green.
- Check that the base is pushed as close to the vehicle seat back as possible and any gap is reduced or eliminated.
- There should be no gap between the vehicle seat and the bottom of the base.

It is acceptable to install with both rigid latch and the vehicle belt. (See vehicle belt installation on the next page.)

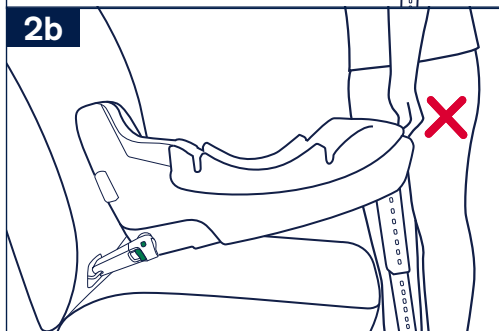
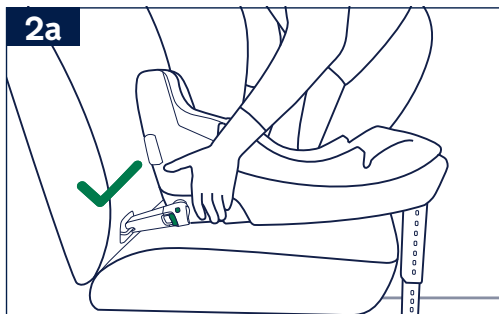

PIPA RELX™ Base Installation Using Lap/Shoulder or Lap Belt Only

- 1 - Position base in a forward facing vehicle seat with the stability leg deployed (if using) (p.38).

It is recommended that you use the stability leg, which reduces rotation in the event of an accident.

- 2 - Lift the lock off release button.
- 3 - Route the **lap belt** across the area labeled “lap belt here.” Route the **shoulder belt** diagonally across the area labeled “shoulder belt here.”
- 4 - If the vehicle belt comes in contact with the belt positioner on the side of the base, route the belt under the positioner.
- 5 - Buckle the vehicle belt. Both the shoulder **AND** lap belt must be under the vehicle belt lock off and belts must lay flat.
- 6 - While pressing the base firmly downward onto the vehicle seat, (1) tighten the vehicle belt by pulling upward on the shoulder belt (2).

(continued on the next page)

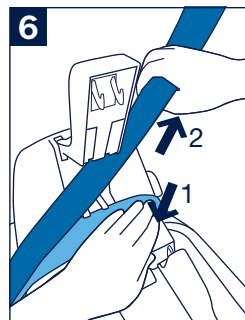
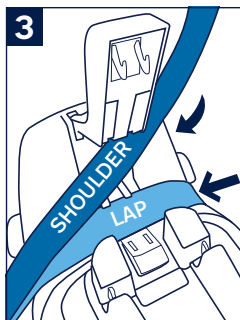
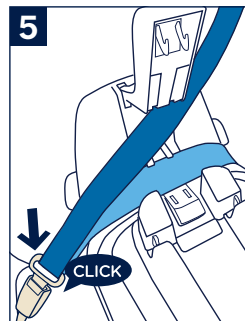
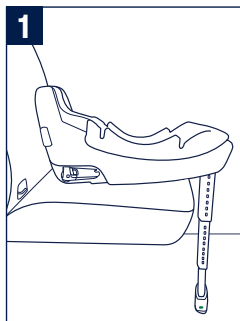

PIPA RELX™ Base Installation Using Lap/Shoulder or Lap Belt Only

(continued)

1 - With the shoulder belt tight, push down on the lock off to close it.

If your vehicle belt locks (check your owner's manual), lock it **only after** the vehicle belt lock off on the base is closed.

Lap Belt Only

If vehicle has a lap belt only, route the lap belt along the lap belt path under the lock off.

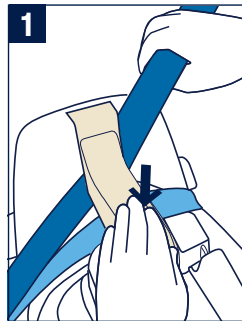

Check the Installation

2 - Test the security of the installation **near the belt path (a)**, not at **the end of the base (or seat) (b)**.

- Base should not move side to side more than 1" **at the belt path**.
- Belt(s) must be tight.
- Belt(s) and buckle must not interfere with attachment of child restraint to base.
- Vehicle belt(s) must lay flat under lock off.
- The stability leg indicator (if using) must show green.
- There should be no gap between the vehicle seat and the bottom of the base.

It is acceptable to install with both rigid latch (p.42) and the vehicle belt.

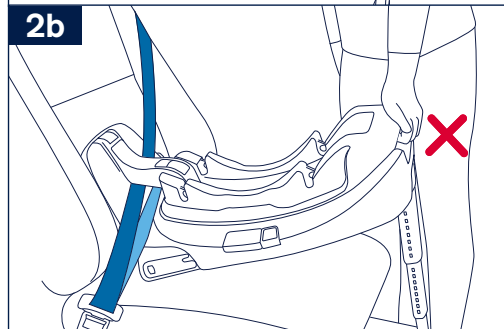
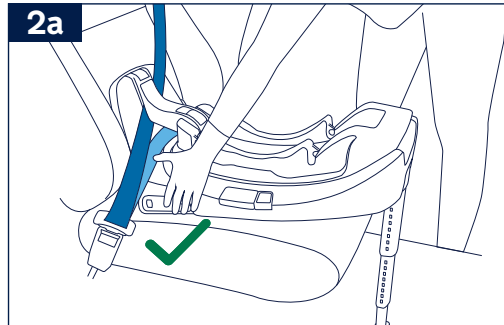

Attaching Child Restraint to PIPA RELX™ Base

1 - After child is properly secured in child restraint, lower child restraint onto base and listen for a click. Check that child restraint is locked onto the base by pulling up on the handle.

⚠ **DO NOT** allow child restraint or handle to contact the vehicle interior (side of car door or seat in front) when installed on base.

Recline Adjustment

PIPA RELX features a recline you can use on the go without uninstalling the seat. Choose a position that matches your child's weight and height.

Recline positions 1 & 2:

4–20 lb, up to 30 inches

Recline positions 3 & 4:

21–30 lb, up to 30 inches

2 - While firmly pushing the recline button all the way down, slide the top of the base. Release the button; if the button does not pop back up, the recline is not locked. Gently push or pull the top of the base until it locks into position.

(continued on the next page)

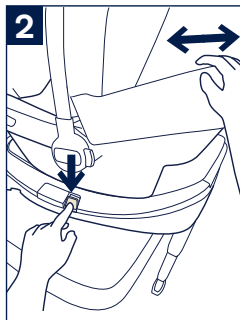

Recline Adjustment *(continued)*

Check the Installation

- After recline adjustment, check that the child restraint is still securely attached to the base by pulling up on the handle.

Releasing Child Restraint from PIPA RELX™ Base

- 1 - To release the child restraint, squeeze the child restraint release button (1) located on the base, then pull the child restraint up (2).

Uninstalling PIPA RELX™ Base

When Installed with Rigid Latch:

- 2 - Squeeze the rigid latch release buttons.
- 3 - Pull the base off of the bars.
- 4 - Rotate the rigid latch back into neutral storage position.

When Installed with Lap and Shoulder Belt:

- 5 - Lift the lock off release button.
- 6 - Unbuckle the vehicle belt and unroute the shoulder and lap belt from the base. Remove the base.

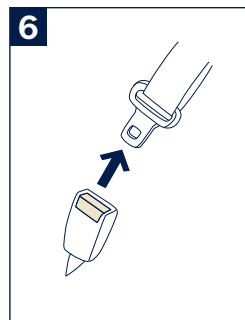
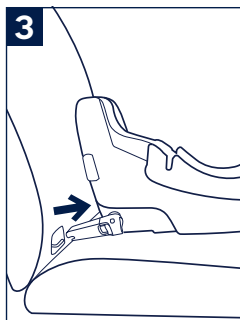
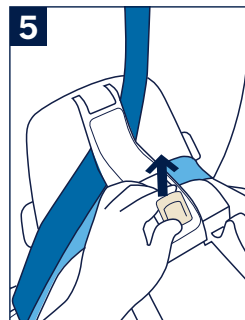
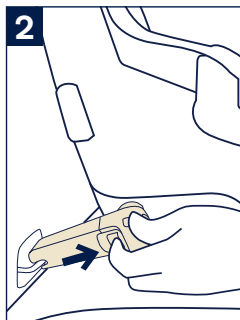
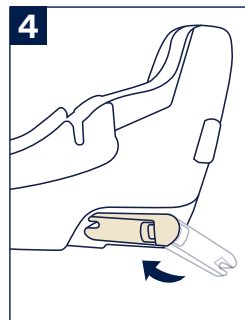
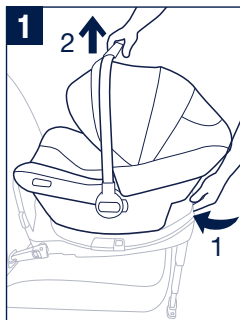

Child Restraint Only Install

This child restraint can be installed without a base in 3 different ways.

- 1** - Place vehicle in park and on level ground. Position child restraint so child is facing the rear of the vehicle.

⚠ Only install in a forward facing vehicle seat.

- 2** - **Option 1:** Route the vehicle lap belt under both lap belt guides. Buckle the vehicle belt. Allow shoulder belt to lay against vehicle seat back as shown.

- 3** - **Option 2:** Route the vehicle lap belt under both lap belt guides. Buckle the vehicle belt. Route the shoulder belt around the back of the child restraint passing through the blue shoulder belt guide.

- 4** - **Option 3:** If your vehicle does not have a shoulder belt, the lap belt only can be used.

- 5** - Adjust the angle of the child restraint. A rolled up towel or foam pool noodle may be used to adjust the amount of recline.

- 6** - Angle is correct when blue line on child restraint (located on the label on the side of the child restraint) is level with ground.

(continued on the next page)

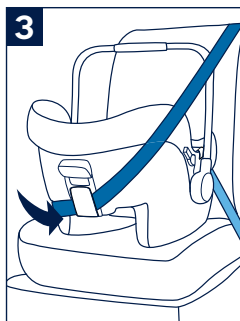
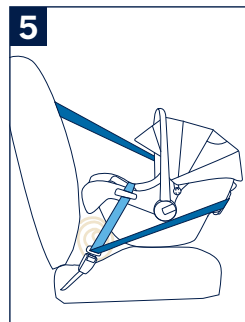
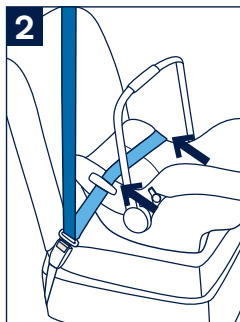
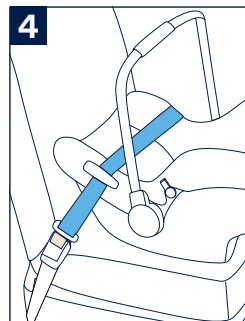
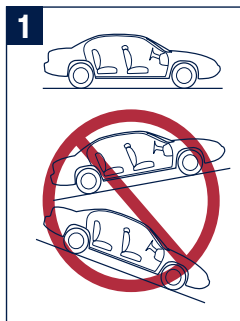

Child Restraint Only Install *(continued)*

- 1 - Tighten vehicle belt while pushing child restraint firmly into vehicle seat. **Lock the vehicle belt.** Refer to vehicle owner's manual for instructions. If you cannot lock the vehicle belt, you must use a locking clip (see note below).

Tension the vehicle belt as much as possible, checking that it is not loose or twisted.

If you need a locking clip, contact Nuna Customer Service:

By phone: 1.855.NUNA.USA

By email: infousa@nunababy.com

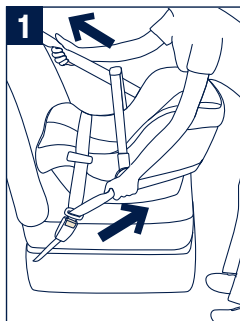

Check Installation

- Blue line on label must be level with ground.
- Vehicle belt must be buckled, tight and must stay locked.
- Child restraint should be stable and not move side to side more than 1 inch at belt path.

Installation in an Aircraft

Position child restraint so that child is facing the aircraft seat back.

- 1 - Route the aircraft lap belt under both lap belt guides and buckle.
- 2 - Adjust the angle of the child restraint. A rolled up towel or blanket may be used to help adjust the amount of recline (1). The angle is correct when the blue line is level with the floor of the aircraft (2).

Tighten the aircraft belt while pushing the child restraint firmly into the seat.

When installing in an airplane using a base, follow the instructions for vehicle installation with a base using lap belt only (p.48–51).

This child restraint is certified for use in commercial aircraft with or without the base. Be sure to contact your airline prior to travel to discuss their use policy.

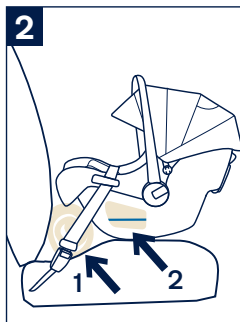
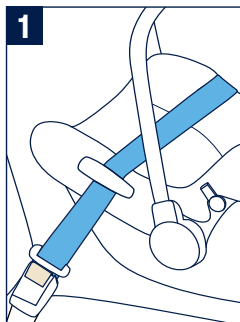

Installation on a Stroller

This infant carrier can attach to Nuna strollers as well as other brands of strollers using adapters* (see next page). Adapters are sold separately. Visit nunababy.com for more information.

*Attaches to Nuna TAVO™ series without adapters

Accessories

PIPA series adapters

The PIPA aire rx can attach to Nuna strollers using adapters*. Instructions are included with the adapters, which are sold separately.

1 - Infant Car Seat Ring Adapter

2 - Infant Car Seat Post Adapters

This infant carrier can also attach to other brands of strollers using adapters. Visit nunababy.com for more information.

PIPA series base

PIPA aire rx is also compatible with the PIPA series base, sold separately.

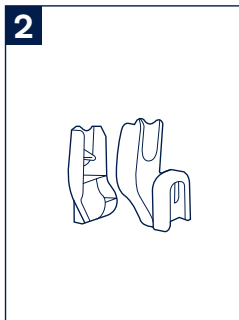
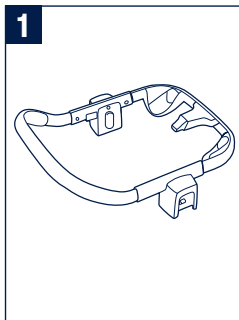

*Attaches to Nuna TAVO™ series without adapters

Cleaning and Maintenance

Refer to the care label attached to the soft goods for washing and drying instructions.

DO NOT attempt to remove the foam under the seat pad.

Use only mild detergent, water and a soft cloth to clean the infant carrier shell, handle and harness straps. Air dry.

To clean the buckle: rinse using warm water. **DO NOT** use any soaps, solvents or lubricants. Using anything other than water can cause the buckle to malfunction. Air dry.

Remove the infant carrier from the vehicle seat if not in use for a long period of time. Put the infant carrier in a cool, dry place and somewhere your child can not access it.

It is normal for fabric to color from sunlight and to show wear and tear after a long period of use, even when used normally.

Check regularly if everything functions properly.

If any parts are torn, broken, or missing, stop using this product.

Nuna Baby Essentials, Inc. Nuna and all associated logos are trademarks.

IM-000640B



Nuna Baby Essentials, Inc.

70 Thousand Oaks Blvd. | Morgantown, PA 19543

1.855.NUNA.USA | nunababy.com